

Avignon 44 4x5

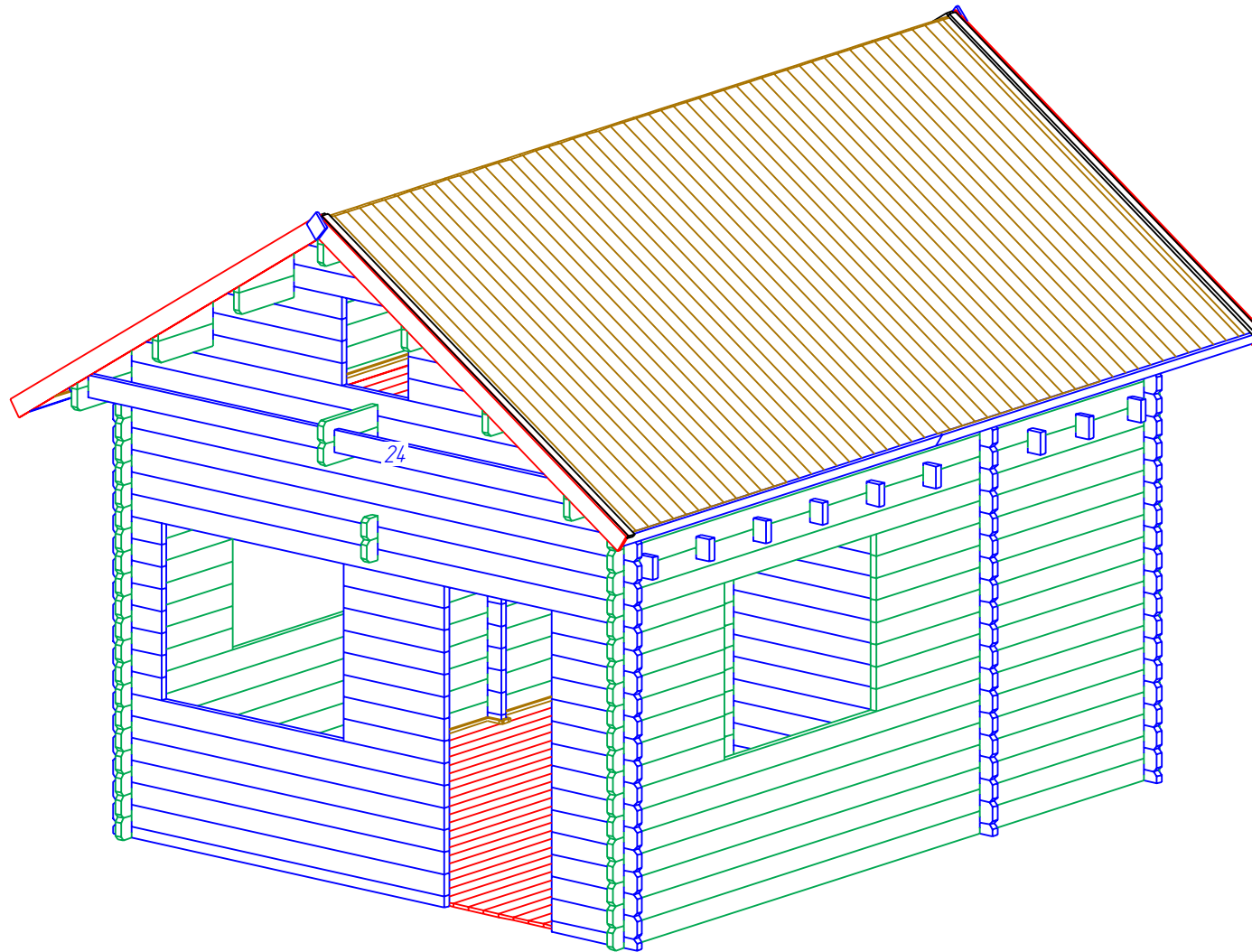

Avignon 44 4x5

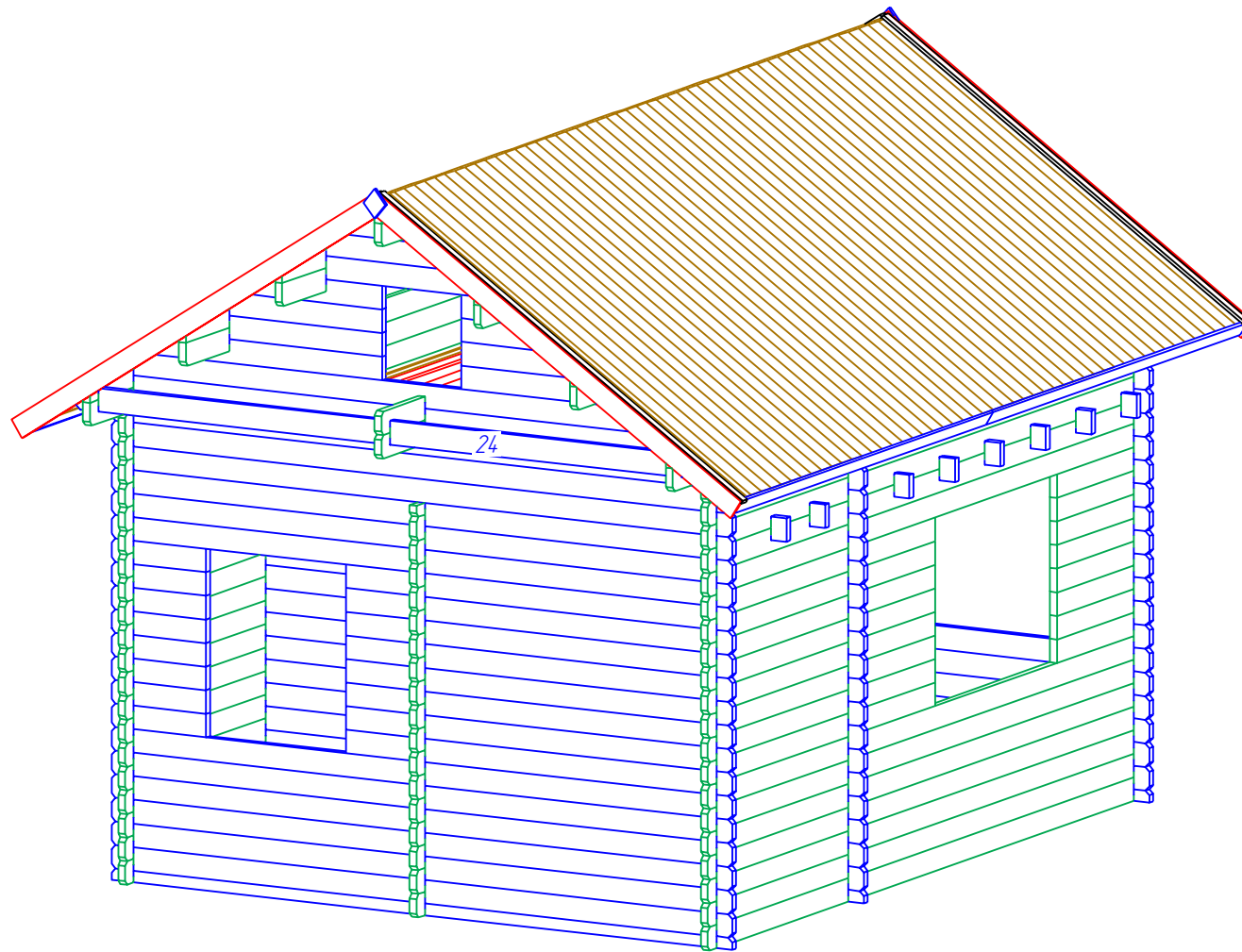

Avignon 44 4x5

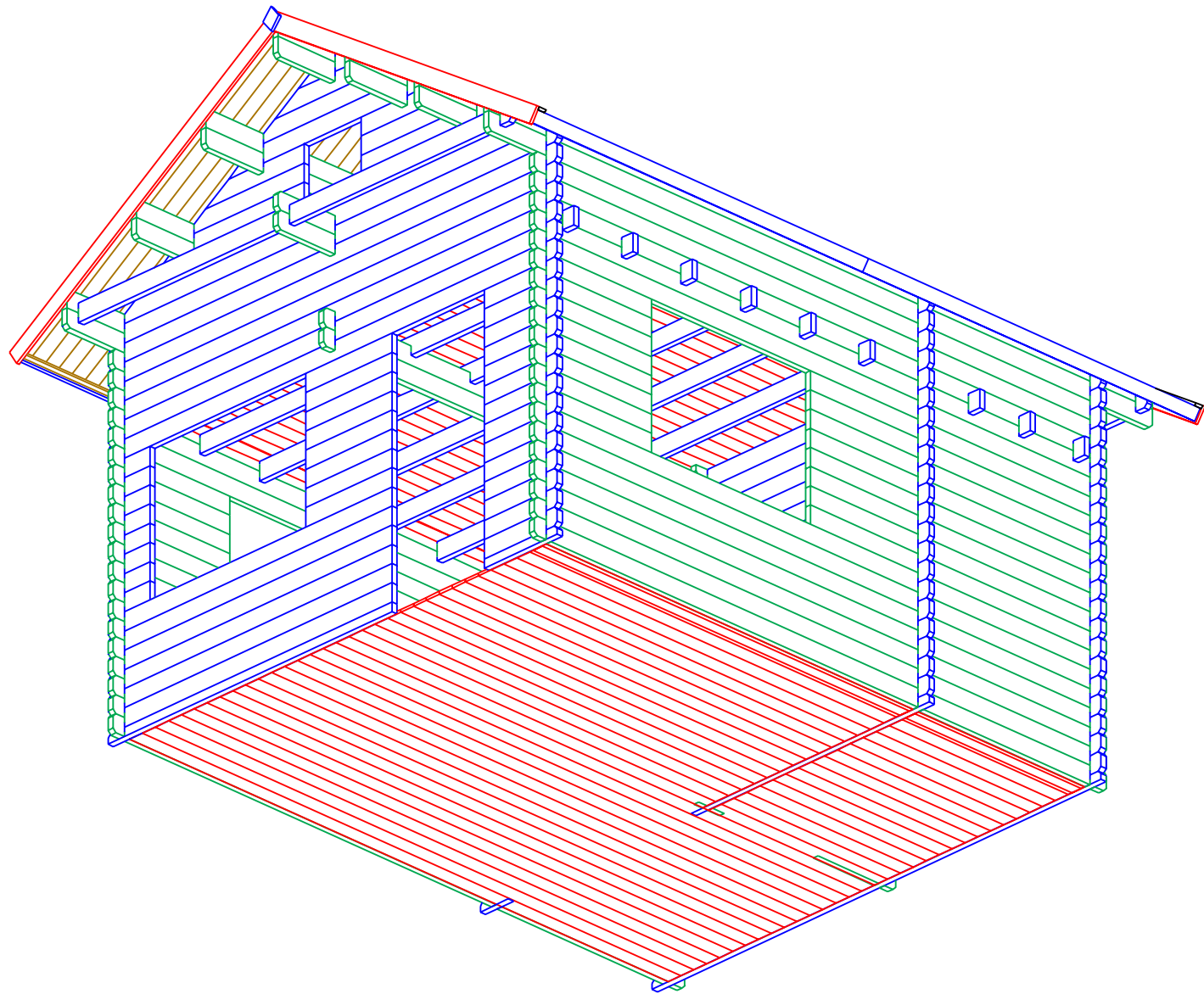

Avignon 44 4x5

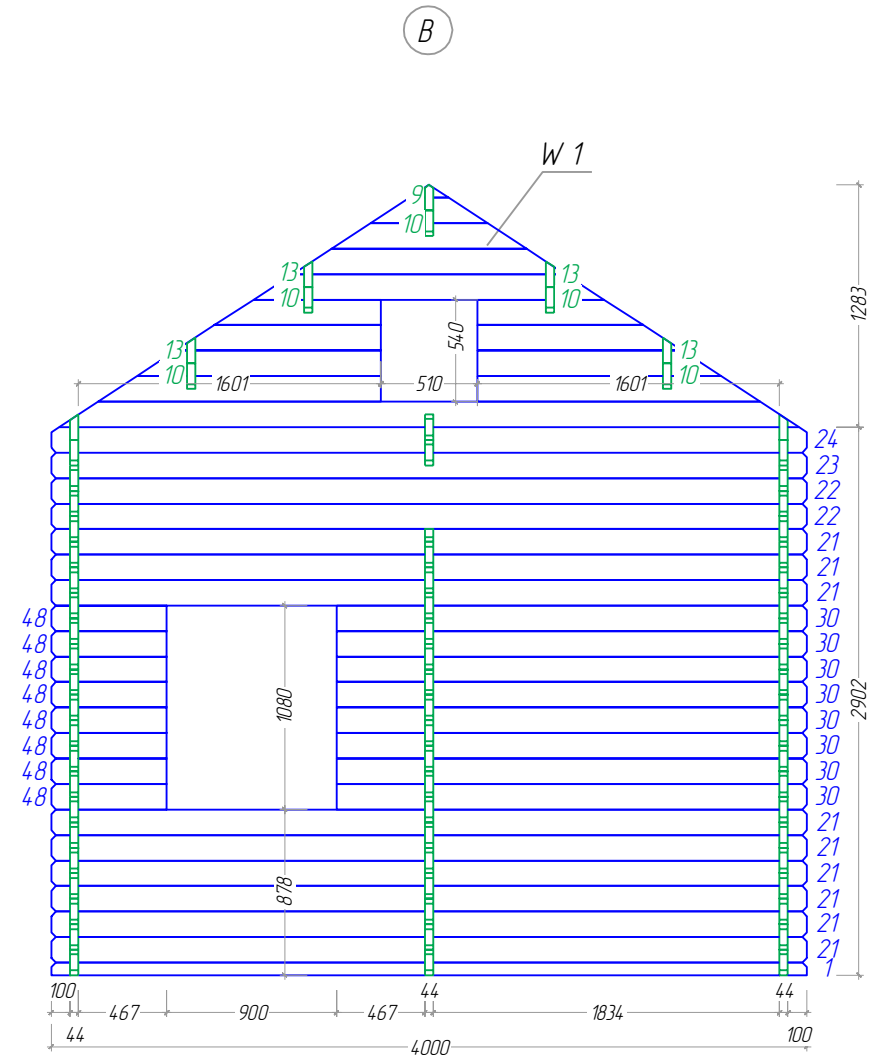
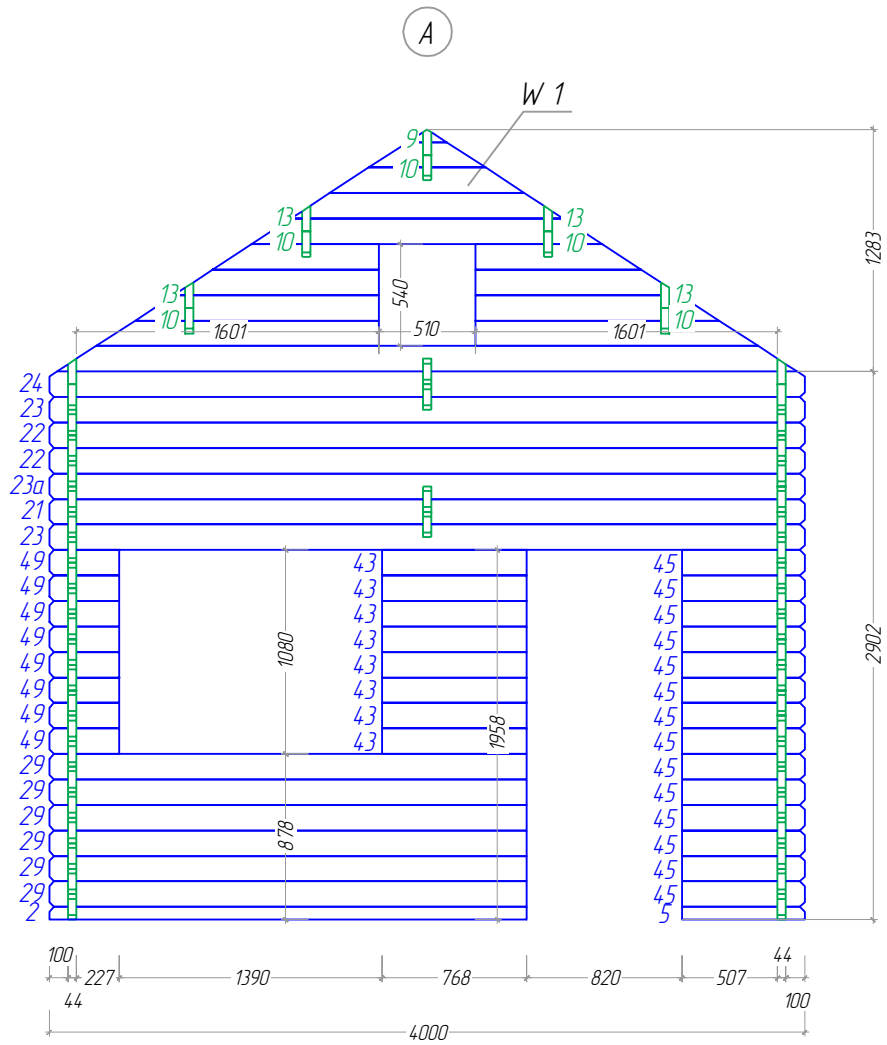

Avignon 44 4x5

C

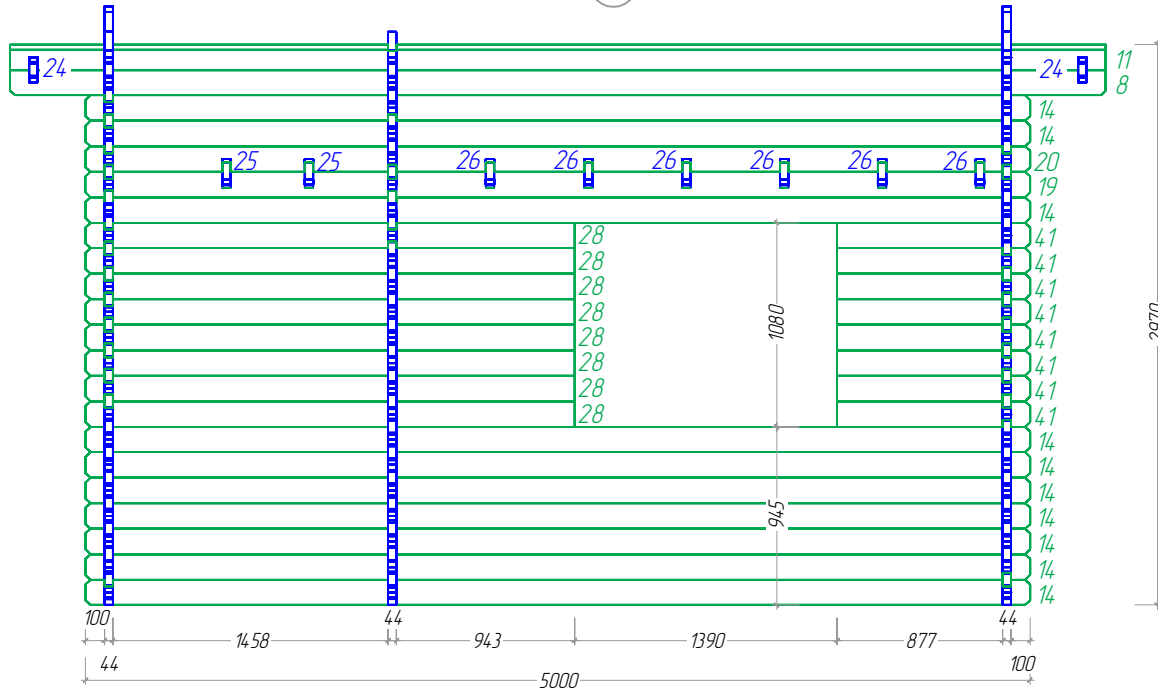

D

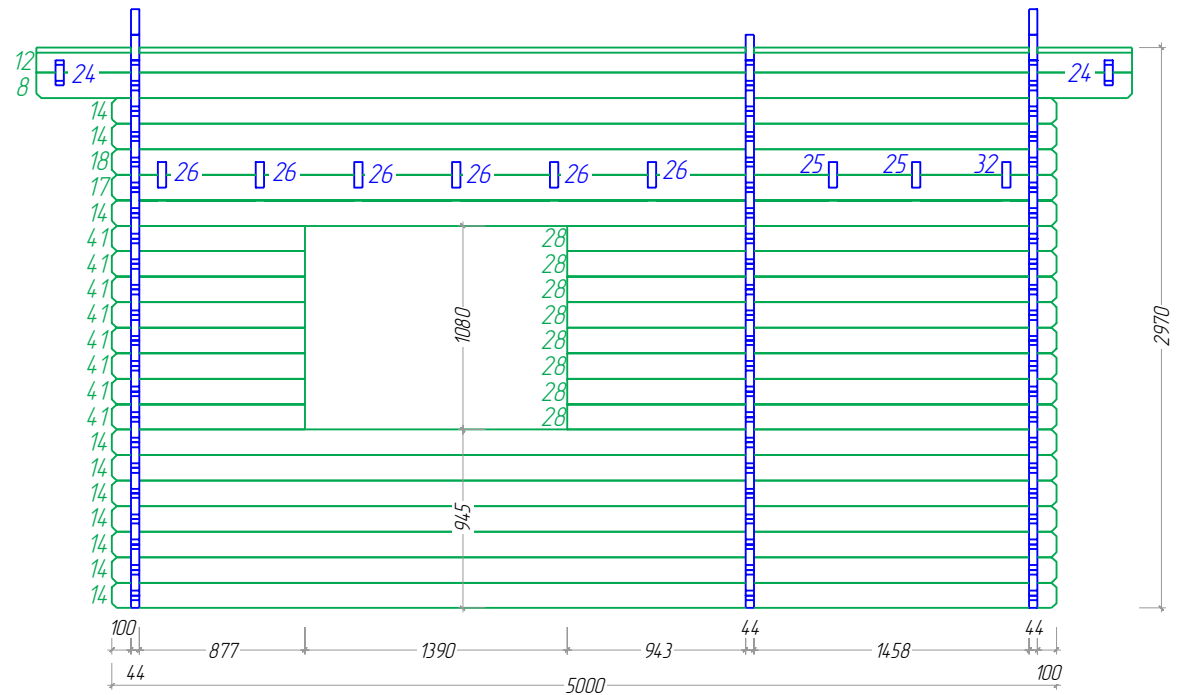

Avignon 44 4x5

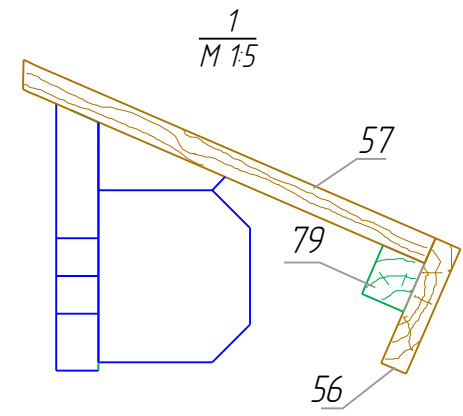
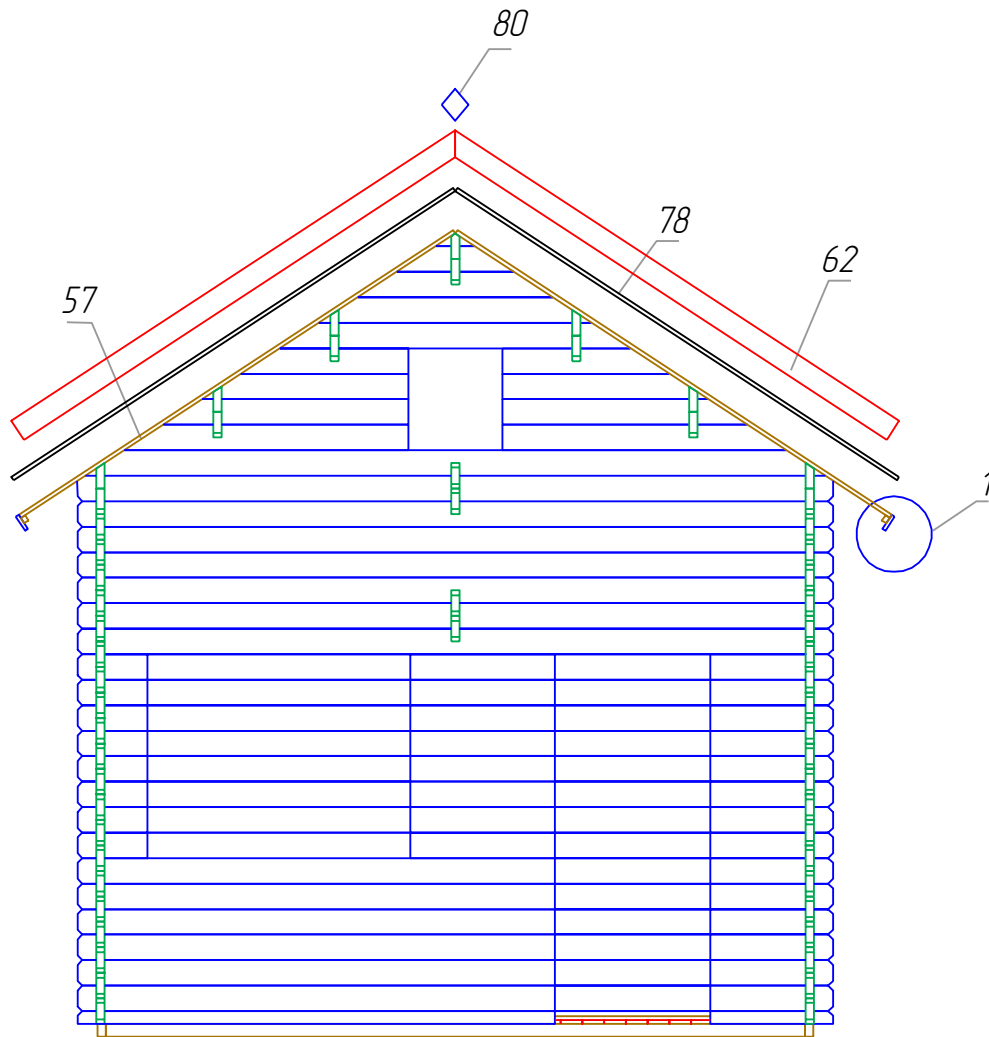

Avignon 44 4x5

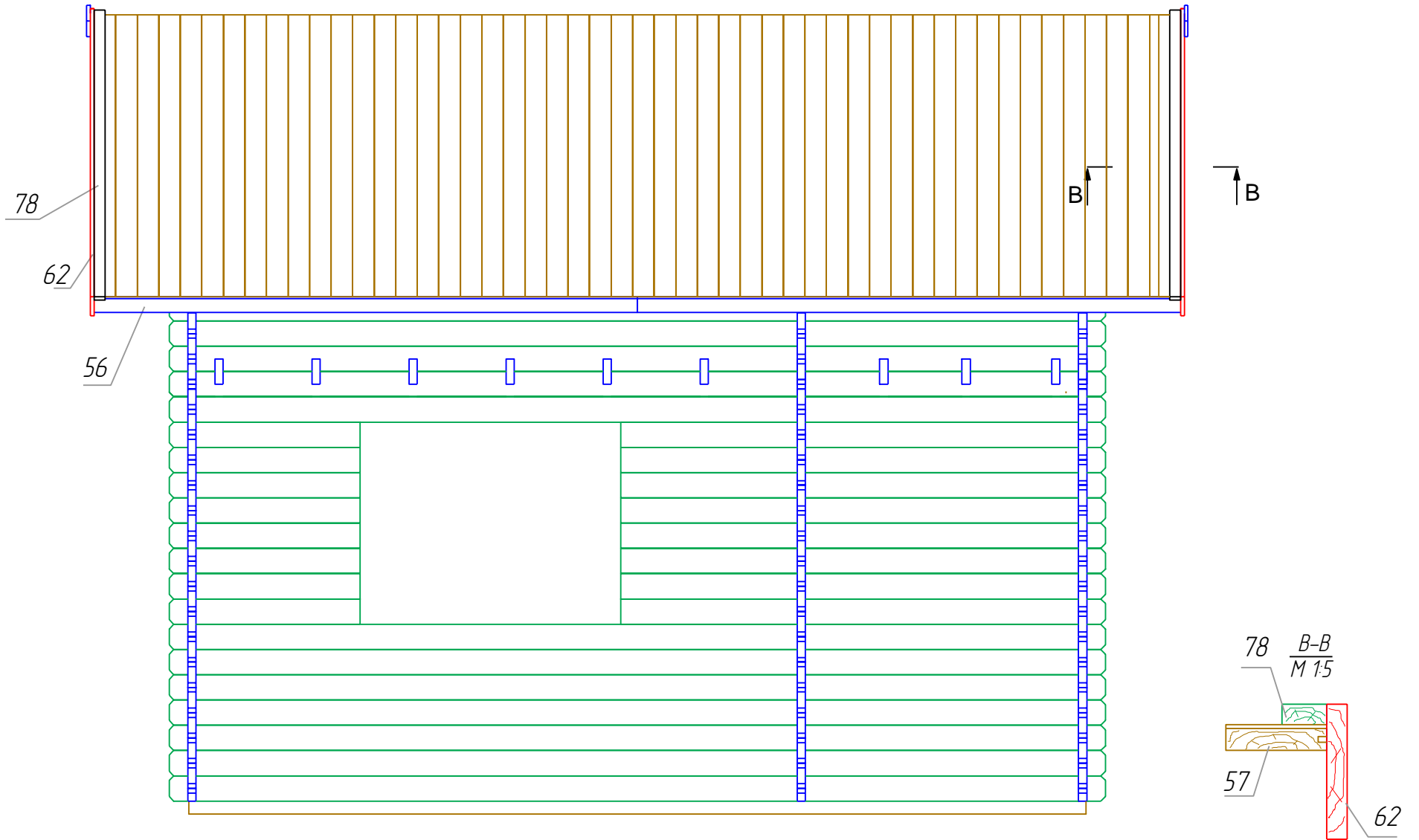

Avignon 44 4x5

Boarding joist plan

Trummplan

Lambourde plan

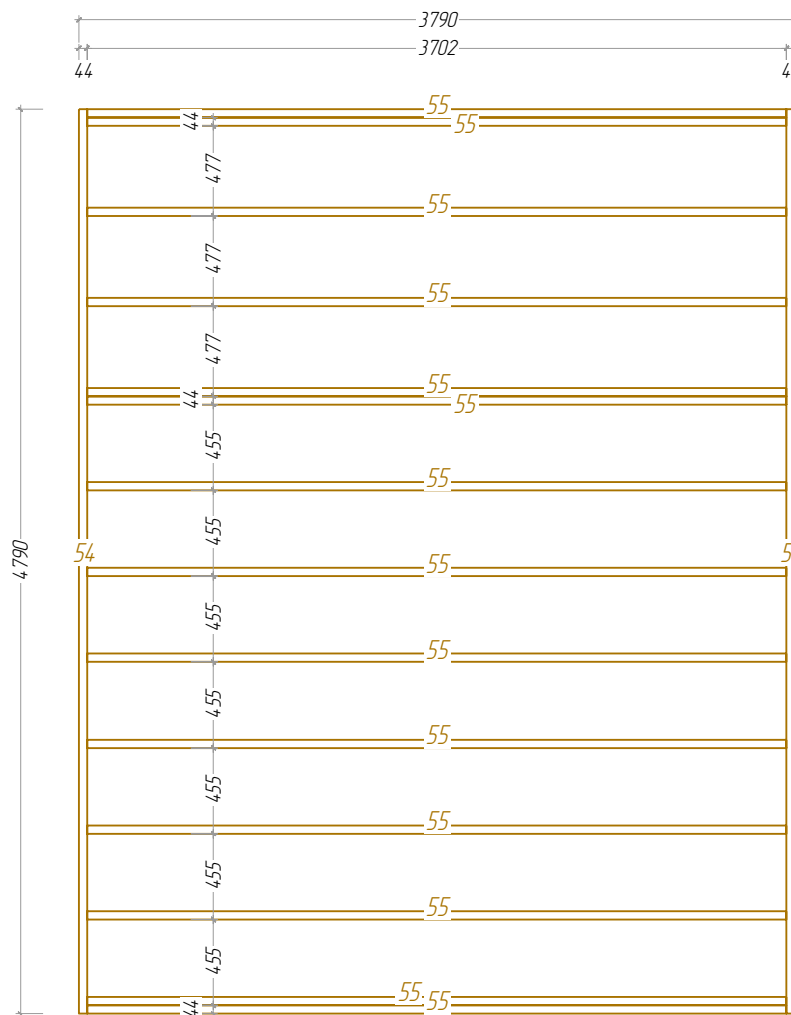



Avignon 44 4x5

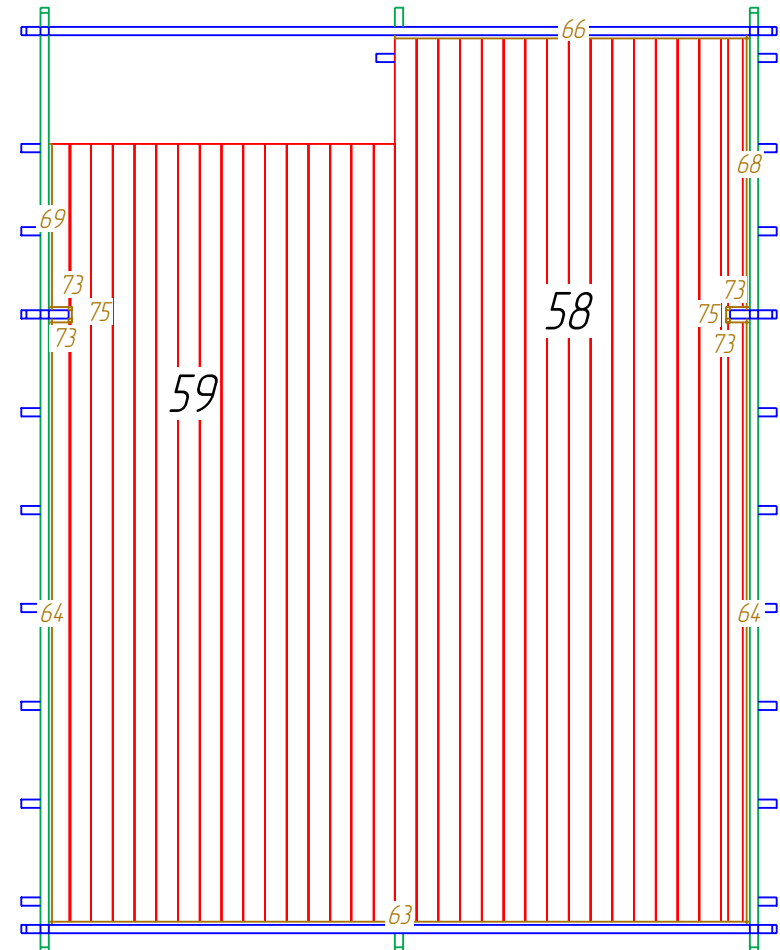
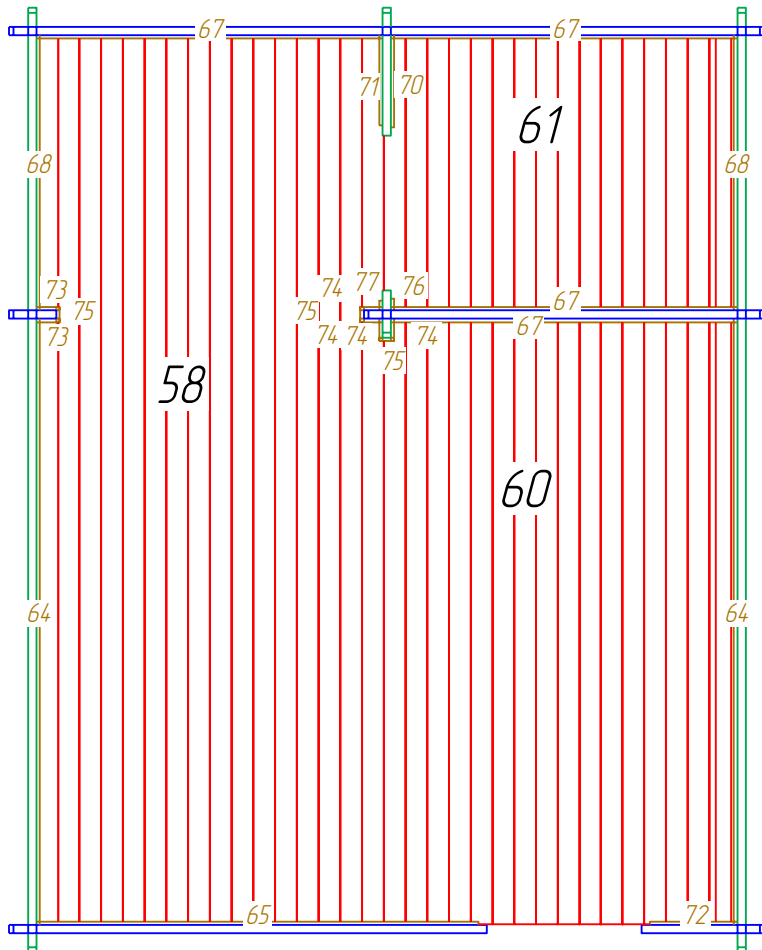





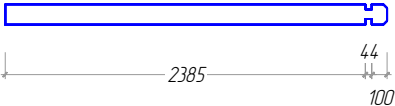
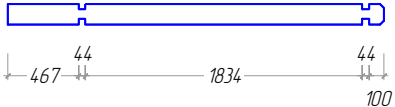
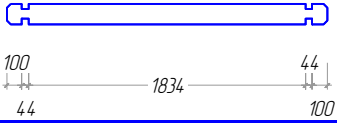
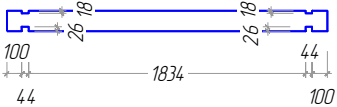
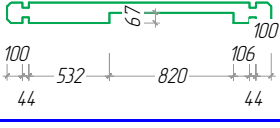
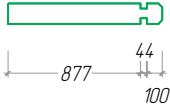
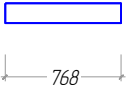
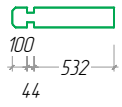
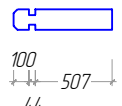
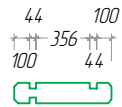
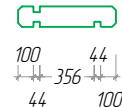
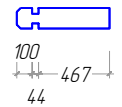

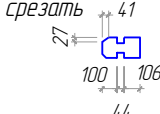
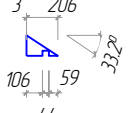

Plan of the floor board
Plan der Furbodenbretter
Le plan des plaches du plancher







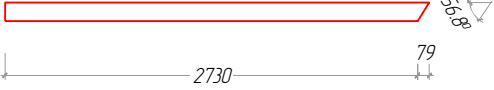













Nº	Avignon 44 4x5	Nr.	Profile (mm)	Lenght (mm)
1		1	44x67,5	4000mm
2		1	44x67,5	2529mm
3		1	44x67,5	2122mm
4		1	44x67,5	1746mm
5		1	44x67,5	651mm
6		1	44x67,5	250mm
8		2	44x135	5800mm
9		1	44x135	5800mm
10		5	44x135	5800mm
11		1	44x135	5800mm
12		1	44x135	5800mm
13		4	44x135	5800mm
14		21+1	44x135	5000mm

№	<i>Avignon 44 4x5</i>	Nr.	Profile (mm)	Length (mm)
16		1	44x135	5000mm
17		1	44x135	5000mm
18		1	44x135	5000mm
19		1	44x135	5000mm
20		1	44x135	5000mm
21		11	44x135	4000mm
22		4	44x135	4000mm
23		3	44x135	4000mm
23a		1	44x135	4000mm
24		4	44x135	4000mm
25		2	44x135	4000mm
26		6	44x135	4000mm
28		16	44x135	2589mm

Nº	Avignon 44 4x5	Nr.	Profile (mm)	Length (mm)
29		6	44x135	2529mm
30		8	44x135	2489mm
31		16	44x135	2122mm
32		1	44x135	2122mm
34		1	44x135	1746mm
41		16	44x135	1021mm
43		8	44x135	768mm
44		14	44x135	676mm
45		14	44x135	651mm
46		2	44x135	644mm
46a		2	44x135	644mm
48		8	44x135	611mm
49		8	44x135	371mm

№	Avignon 44 4x5	Nr.	Profile (mm)	Length (mm)
50		36	44x135	250mm
51		2	44x135	250mm
53		2	44x135	209mm
54	<p>Foundation Fundament Solvie</p> 	2	44x68	4790mm
55	<p>Foundation Fundament Solvie</p> 	14	44x68	3702mm
56	<p>Roof side boards Traufenbrett Planche de rive</p> 	4	18x90	2900mm
57	<p>Roof boards. Dachbretter Volige</p> 	102+1	20x115	2750mm
58	<p>Floor boards Fu ssboden Lame de plancher</p> 	33+2	20x115	4708mm
59	<p>Floor boards Fu ssboden Lame de plancher</p> 	16	20x115	4132mm
60	<p>Floor boards Fu ssboden Lame de plancher</p> 	17	20x115	3206mm
61	<p>Floor boards Fu ssboden Lame de plancher</p> 	17	20x115	1454mm
62	<p>Fascia board Giebelblende Planch de rive facade</p> 	4	20x120	2809mm
63	<p>Floor edge trim Fu bleisten Plinthe plancher</p> 	1	20x18	3712mm

Nº	<i>Avignon 44 4x5</i>	Nr.	Profile (mm)	Lenght (mm)
64	Floor edge trim Fu bleisten Plinthe plancher 	4	20x18	3210mm
65	Floor edge trim Fu bleisten Plinthe plancher 	1	20x18	2342mm
66	Floor edge trim Fu bleisten Plinthe plancher 	1	20x18	1878mm
67	Floor edge trim Fu bleisten Plinthe plancher 	4	20x18	1834mm
68	Floor edge trim Fu bleisten Plinthe plancher 	3	20x18	1458mm
69	Floor edge trim Fu bleisten Plinthe plancher 	1	20x18	880mm
70	Floor edge trim Fu bleisten Plinthe plancher 	1	20x18	489mm
71	Floor edge trim Fu bleisten Plinthe plancher 	1	20x18	479mm
72	Floor edge trim Fu bleisten Plinthe plancher 	1	20x18	464mm
73	Floor edge trim Fu bleisten Plinthe plancher 	6	20x18	124mm
74	Floor edge trim Fu bleisten Plinthe plancher 	4	20x18	118mm
75	Floor edge trim Fu bleisten Plinthe plancher 	5	20x18	80mm
76	Floor edge trim Fu bleisten Plinthe plancher 	1	20x18	63mm

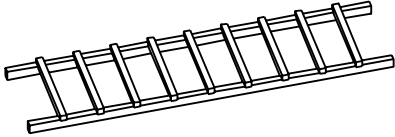
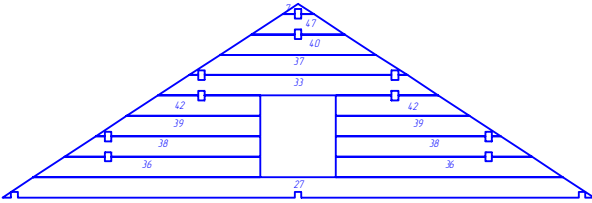
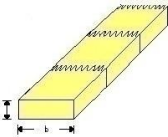
N°	Avignon 44 4x5		Nr.	Profile (mm)	Lenght (mm)
77	Floor edge trim Fu bleisten Plinthe plancher		1	20x18	53mm
78	Roofing felt fillet Giebelabschlussbrett Latte de finition couverture		4	20x58	2796mm
79	Roof edge reinforcement Traufenleiste Tasseau		4	28x34	2900mm
80	Diamond Route Diamant		2	20x120	120mm
81	Storm protection		4	28x34	1900mm
Door Tur La porte	820 x 1958 MM		2		
Window Fenetre Fenster	900 x 1080 MM		1		
Window Fenetre Fenster	1390 x 1080 MM		3		
Window Fenetre Fenster	510 x 540 MM		2		
			1		
W1			2		
		Les planches n8, n9, n10, n11, n12, n13 sont jointes par entures multiples afin de garantir la stabilité de la construction			

Avignon 44 4x5

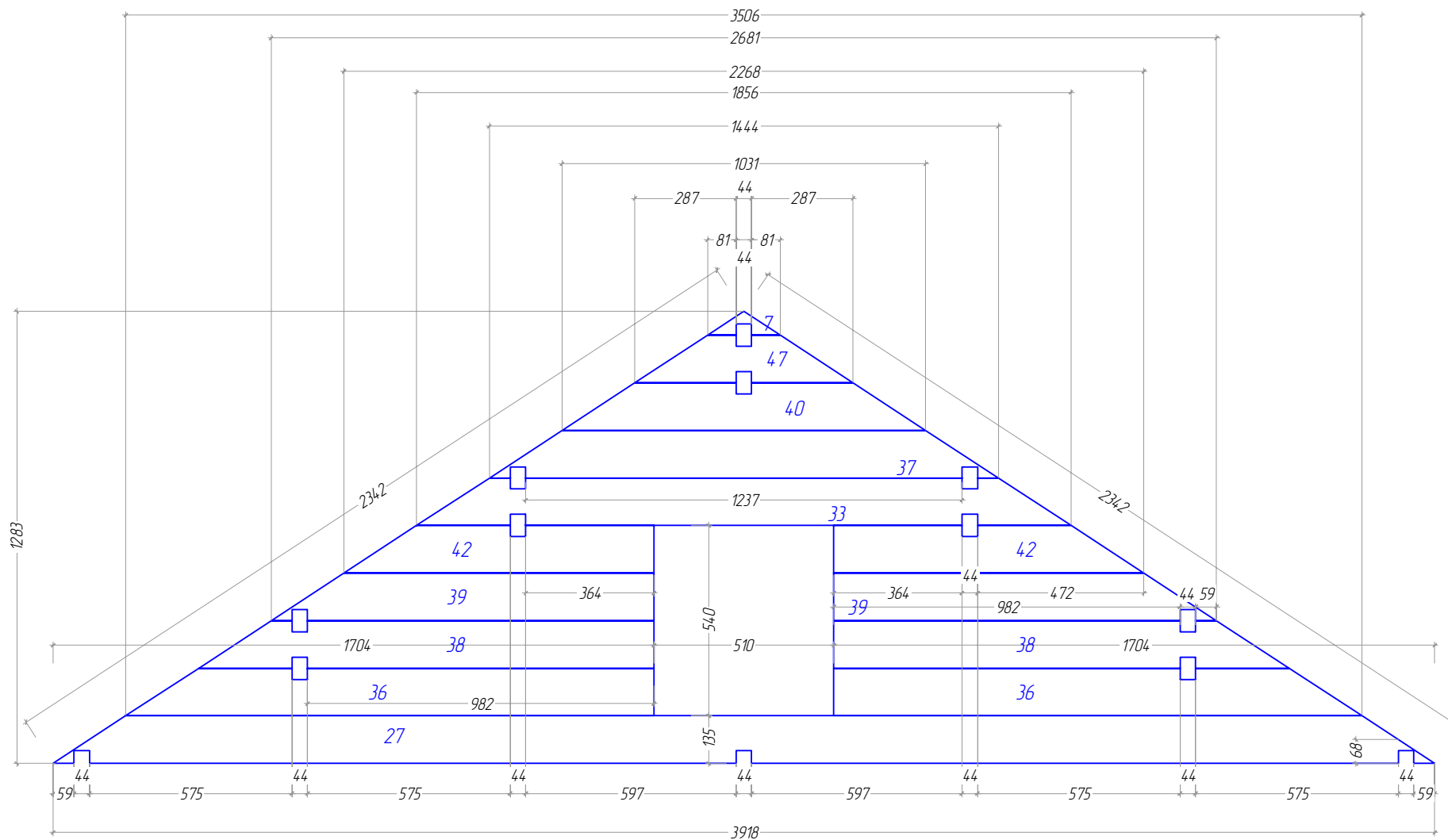

Storm protection

